

TECHNICAL DATA SHEET

TRAPEZOID BLADE NO. 8852



TRAPEZOID BLADE NO. 8852 from MARTOR is a high-quality blade made of steel with TiN-coating. It is very sharp and has two cutting edges that can be used one after the other for a long service life. The blade is 53 mm long, 19 mm wide and 0.63 mm thick.

TRAPEZOID BLADE NO. 8852 is available under order number 8852.70 in a dispenser of 10.

PRODUCT DETAILS

Order No.	NO. 8852.70
Blade size (L x W)	53 x 19 mm
Material thickness	0.63 mm
Weight Blade	3.2 g
Basic material	Steel
Refinement/ Version	TiN
Ground	2-sided ground-edge
Blade facets	Double bevel edge-ground
Blade characteristics	2-cutting edge blade

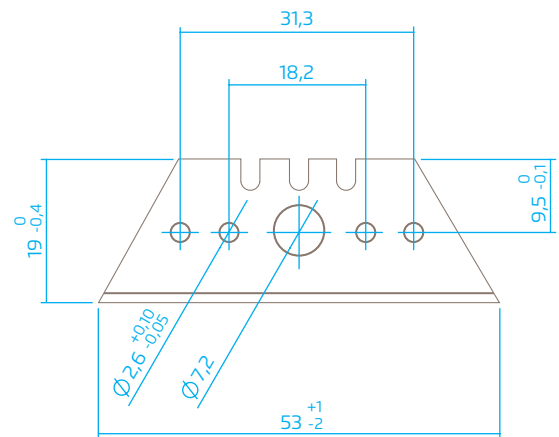

PACKAGING DETAILS

Packaging unit (PU)	10 in dispenser
Size PU	64.3 x 25.8 x 14.0 mm
Weight PU	30.7 g
EAN Code PU	4002632918360
Quantity in outer pack	10 dispensers
Size outer pack	128 x 29 x 67.0 mm
Weight outer pack	420 g
EAN Code outer pack	4002632969683
Customs tariff number	82119400



PRODUCT FEATURES

Technical features



TiN-coated



2-sided ground-edge



2-cutting edge blade

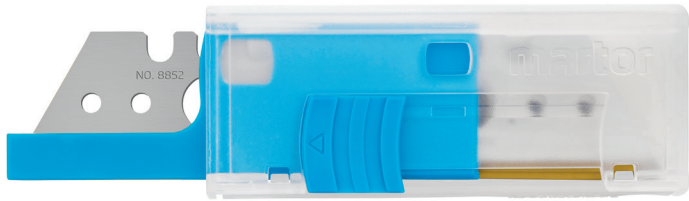

MOUNTABLE IN

The blade can be used in the following MARTOR knives: SECUNORM MIZAR, SECUNORM MULTISAFE, SECUNORM 300, SECUNORM 500, SECUNORM PROFI, ARGENTAX MULTIPOS.

SAFETY ADVICE



CAUTION: The blade is sharp and can result in serious and deep cuts. Therefore, never reach into the blade!

Only use cutting tools that are in perfect condition with sharp, clean and undamaged MARTOR blades. Also make sure that the knife's operation is not impaired by the material to be cut or by dirt or particle deposits around the blade.

1. Replacement of spare parts: Replace any blades that become dull at the right time! Dispose of old blades in a proper fashion. They should not be placed in a waste paper bin, as this poses a considerable danger of injuries.

2. Non-use of the knife: Always secure the blade in such a way (depending on product type) that injuries due to cuts are excluded. Store the knife in a secure place.

3. Care instructions: To guarantee a long service life, always keep the knife clean and do not expose it to unnecessary soiling and humidity.

CAUTION: No liability will be assumed for consequential losses. Subject to technical changes and errors! This knife does not belong in the hands of children!



Distributed by: SAURYA HSE PVT LTD

**Ho: C-112A, Kailash Business Park, Veer Sawarkar Marg, Vikhroli (West), Mumbai – 400079, Maharashtra, India
T: +91 22 4065 5555 | E: commercial@sauryahse.com | W: www.sauryahse.com**